

widok z przodu (1)

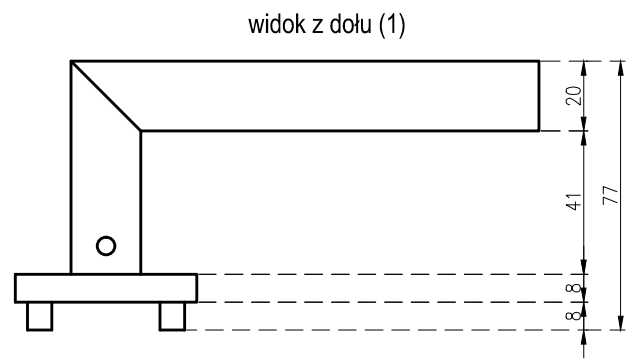

widok z dołu (1)

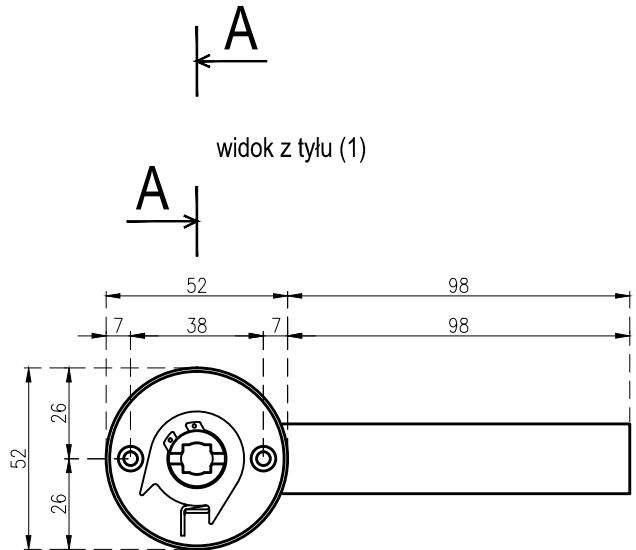

widok z tyłu (1)

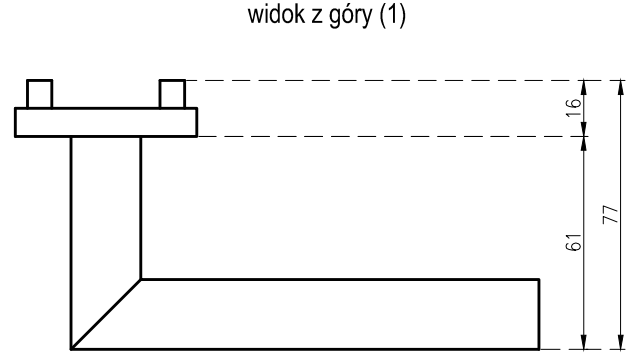

widok z góry (1)

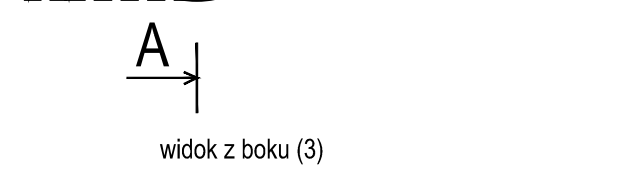

widok z boku (3)

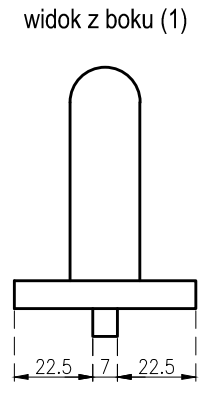

widok z boku (1)

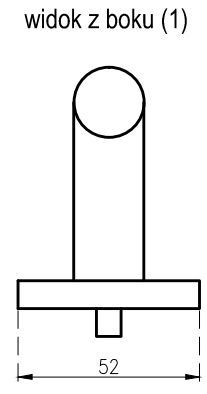

widok z boku (1)

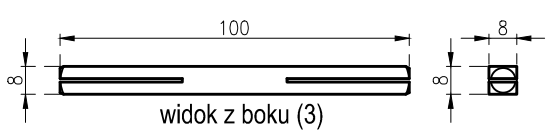

widok z boku (3)

widok z przodu (2)

widok z boku (2)

widok z tyłu (2)

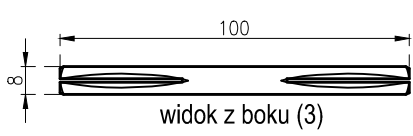

widok z boku (3)

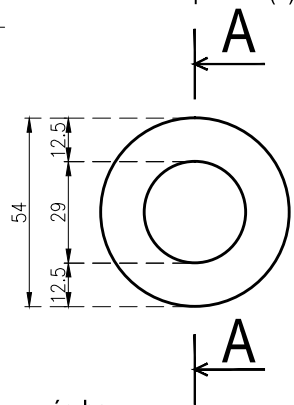

A

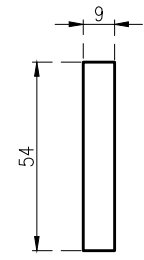

A

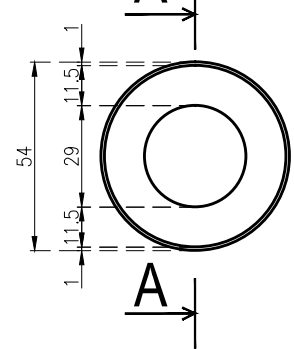

A

A

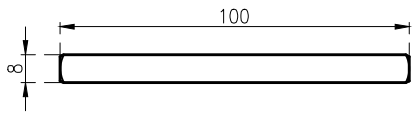

śruba imbusowa (4)



- W zestawie:
- 2x rękojeść zespolona z adapterem drzwiowym (1)
 - 2x maskownica (2)
 - trzpień (3)
 - 2x śruba imbusowa (4)
 - 2x śruba M4x50mm
 - klucz imbusowy 3mm

enger	ENGER Robert Kwiecień, ul. Zagrody 25, 32-200 Miechów tel. 41 389 01 03 biuro@enger.pl			
	Producent	ENERG	Kraj pochodzenia	Polska
Artykuł	Kłamka OVAL 1701		25.11.2017	
Rys.1	Widoki		Skala 1:2	